

Product Datasheet

FIRE CABINETS



Fire Extinguisher
(Page 2)



Fire Hose Reel
(Page 3)



Flush Type Hose Reel Cabinet
(Page 4)

GRP Fire cabinets are used for indoor and outdoor application with weatherproof and antistatic properties, finding their major application in accommodating fire hose reels, extinguishers and other firefighting equipment. They are manufactured in UV resistant and Flame red-RAL3000 color with clear labeling. They are equipped with locks which can be unlocked easily during an emergency situation. These cabinets are perfectly suited for Industrial and Commercial use.

Features	Specifications	Other Options
Weatherproof	UV resistant - ASTM G154 Certified	
High Impact Resistant	IK8, BS EN 62262-22002 Certified	IK10, Anti-Vandal sandwich construction with encapsulated plywood
Fire Retardant and Self Extinguishing	UL 94, BS 476:Part 7:1997 Class 2 Certified	Higher fire resistance upto Class 0
Anti-Static	IEC-60079-0 Certified	
Wall Thickness	3mm generally and 5mm at stress points	Increased wall thickness
Semi-gloss External Gelcoat Finish	Red RAL 3000	Alternate RAL colors available on request refer to RAL Color chart on page 4
Long Life & High Temperature Resistant Rubber Seal	EPDM rubber gasket installed	Please refer page 7
Corrosion Resistant	SS 316 Stainless steel accessories	Please refer page 6
Customizable	Alternate sizes, accessories and options to match required specifications	Please refer page 6



View Our Product Catalogue



FIRE CABINETS

Fire Extinguisher

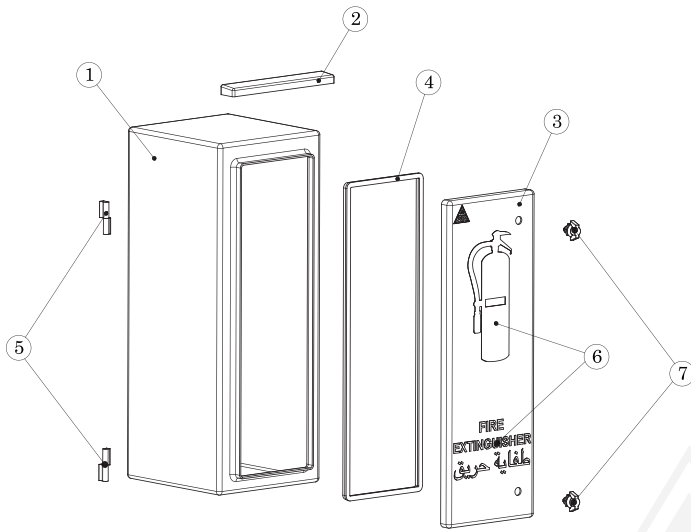

1. GRP enclosure body
2. GRP small canopy
3. GRP door
4. EPDM rubber gasket
5. SS 316 lift-off type hinges
6. PVC sticker
7. Polyamide wing type lock

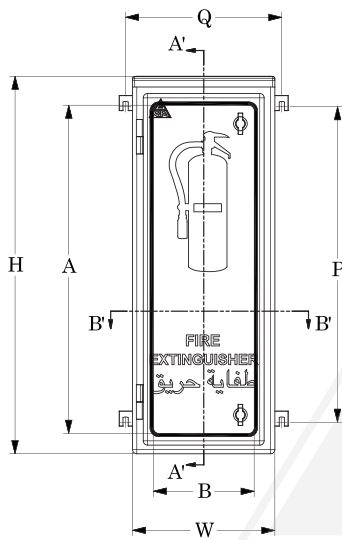

FRONT ELEVATION

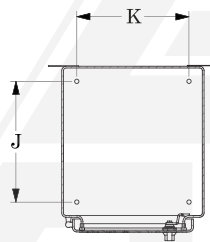

SECTION B'-B'



SECTION A'-A'

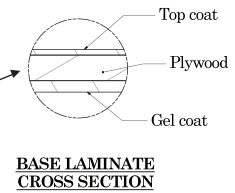

BASE LAMINATE CROSS SECTION

Measurements

All dimensions in mm

SI No.	Designed For	Product Reference	Internal Size			Clear Opening		C/C of Wall Brackets		C/C of Foundation Bolts		Total Weight (Kg ± 1)
			H	W	D	A	B	P	Q	K	J	
1	1 No 5 kg CO2 Extinguisher	FC 098063028	985	635	285	865	515	890	680	535	235	31
2	1 No 5 kg CO2 Extinguisher	FC 100060040	1000	600	400	880	480	895	645	500	350	32
3	2 Nos 5 kg CO2 Extinguisher	FC 100090040	1000	900	400	880	780	895	945	800	350	44
4	1 No 9 kg Fire Extinguisher	FC 080060040	800	600	400	680	480	695	645	500	350	28
5	2 Nos 9 kg Fire Extinguisher	FC 100060040	1000	600	400	880	480	895	645	500	350	32
6	2 Nos 12 kg Extinguisher	FC 100090040	1000	900	400	880	780	895	945	800	350	44

Sizes mentioned are standard sizes. Customized sizes are available, please submit your enquiry online or email us at sales@grpindustries.com

Disclaimer: GRP Industries reserves the right to modify this document without prior notice

FIRE CABINETS

Fire Hose Reel

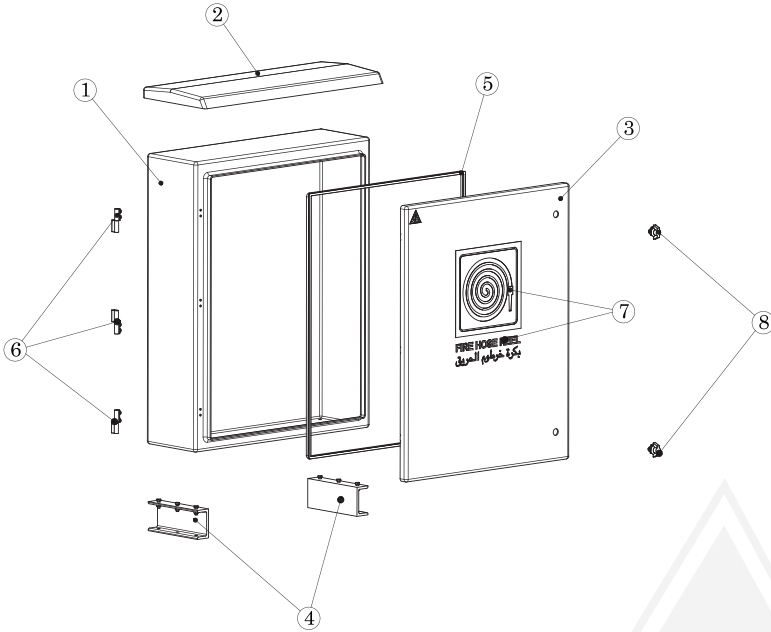

1. GRP enclosure body
2. GRP large rain canopy
3. GRP door
4. GRP pedestal
5. EPDM rubber gasket
6. SS 316 lift-off type hinges
7. PVC sticker
8. Polyamide wing type lock

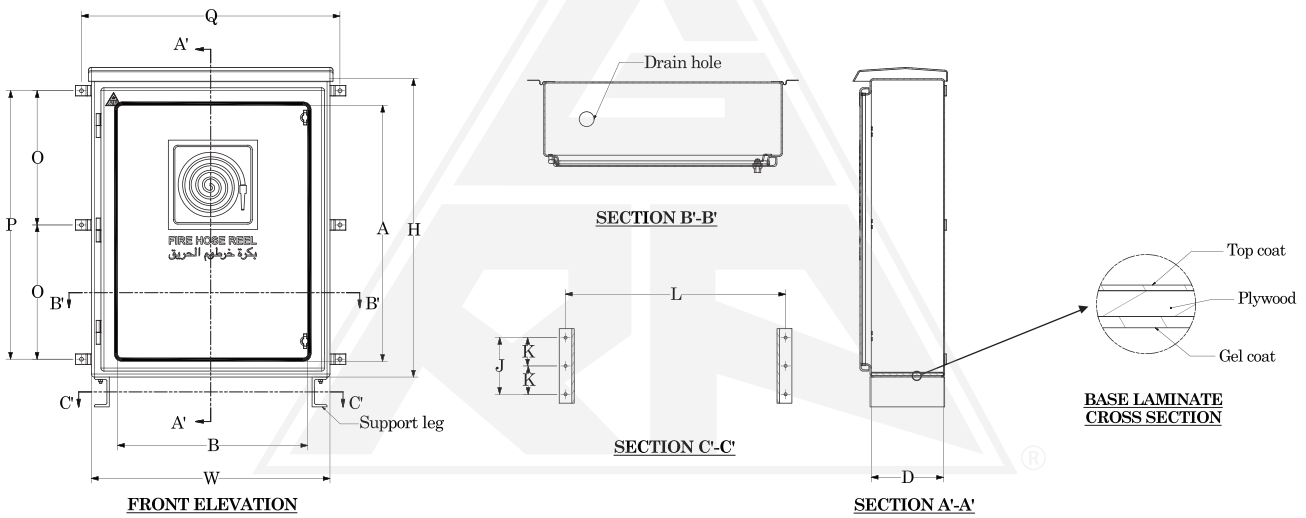

Measurements

All dimensions in mm

SI No.	Designed For	Product Reference	Internal Size			Clear Opening		C/C of Wall Brackets			C/C of Foundation Bolts		Total Weight (Kg ± 1)
			H	W	D	A	B	O	P	Q	K	J	
1	1 No 20m Fire hose and Nozzle	FC 060060030	600	600	300	490	500	-	495	645	500	250	18
2	1 No 20m Fire Hose and Nozzle	FC 100080025	1000	800	250	880	680	-	890	865	700	200	33
3	2 No 30m Fire Hose and Branch Pipe	FC 100090040	1000	900	400	880	780	-	895	970	800	350	44
4	4 No 23 m Fire hose and Branch Pipe	FC 130080040	1300	800	400	1180	680	595	1190	870	700	350	48

Sizes mentioned are standard sizes. Customized sizes are available, please submit your enquiry online or email us at sales@grpindustries.com

FIRE CABINETS

Flush Type Hose Reel Cabinet

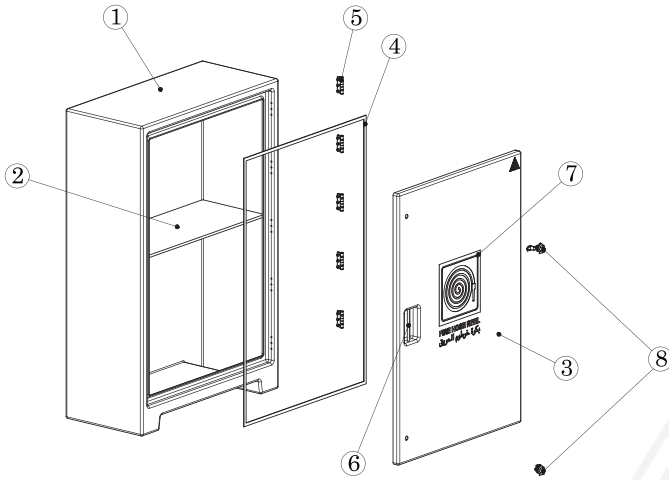

- 1. GRP enclosure body
- 2. GRP Partition
- 3. GRP door
- 4. EPDM flat gasket
- 5. SS 316 butt type hinges
- 6. Aluminium handle
- 7. PVC sticker
- 8. Polyamide wing type lock

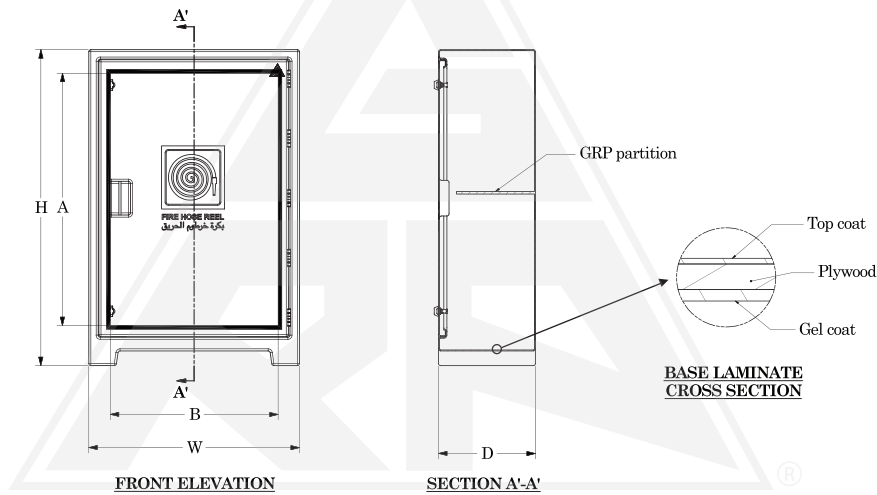

Measurements

All dimensions in mm

SI No.	Designed For	Product Reference	Internal Size			Clear Opening		C/C of Wall Brackets			C/C of Foundation Bolts		Total Weight (Kg ± 1)
			H	W	D	A	B	O	P	Q	K	J	
1	4 Nos 30m Fire Hose and Branch Pipe	FC 150100046	1500	1000	460	1240	840	-	1200	1040	-	-	64

Sizes mentioned are standard sizes. Customized sizes are available, please submit your enquiry online or email us at sales@grpindustries.com

FIRE CABINETS

Material Properties of Glass Reinforced Polyester

Weather Proof

Rigid Construction

Corrosion Resistant

High Impact Resistant

Suitable for outdoor use -10°C to +80°C and 100% humidity

Mechanical Data

Titles	Values	Unit	Test Method
Tensile Strength	110 ± 25	Mpa	BS 2782:P10, Method - 1003
Flexural Strength	170 ± 25	Mpa	BS 2782:P10, Method - 1005
Impact Strength	IK8 = 5 joule impact		BSEN 62262:2002 IK8
Tensile Modulus	8000	Mpa	ISO 527-1/2-1993
Flexural Modulus	7000	Mpa	ISO 178-1993
Hardness (Barcol 934-1)	40-45		ASTMD-2583-1987
Tensile Elongation	1.8	% length	ISO 527-1/2-1993
Co-efficient of Thermal Expansion	26 x 10 ⁻⁶	m/°C	
Thermal Conductivity (k)	0.2	W/mK	

Physical Data

Titles	Values	Unit	Test Method
Water Absorption (7days)	31	mg	BS 2782, Part4: Method 430 A-83
External Finish	Plain semi gloss UV resistant		
Internal Finish	Reasonably smooth flowcoat finish		
Gel Coat Thickness	350-450	microns	
Glass Content	35 ± 5	% weight	BS 2782 P10, Method 1002
Loss on Ignition	65 ± 5	% weight	BS 2782 P10, Method 1002

Standard Colors

RAL 3000

Other Options Available

RAL 1000	RAL 1001	RAL 1002	RAL 1003	RAL 1004	RAL 1005	RAL 1006	RAL 1007	RAL 7008	RAL 7009
RAL 1011	RAL 1012	RAL 1013	RAL 1014	RAL 1015	RAL 1016	RAL 1017	RAL 1018	RAL 7021	RAL 7022
RAL 1019	RAL 1020	RAL 1021	RAL 1023	RAL 1024	RAL 1027	RAL 1028	RAL 1032	RAL 7033	RAL 7034
RAL 1033	RAL 1034	RAL 1037	RAL 2000	RAL 2001	RAL 2002	RAL 2003	RAL 2004	RAL 7042	RAL 7043
RAL 2008	RAL 2009	RAL 2010	RAL 2011	RAL 2012	RAL 3000	RAL 3001	RAL 3002	RAL 8007	RAL 8008
RAL 3003	RAL 3004	RAL 3005	RAL 3007	RAL 3009	RAL 3011	RAL 3012	RAL 3013	RAL 8019	RAL 8022
RAL 3014	RAL 3015	RAL 3016	RAL 3017	RAL 3018	RAL 3020	RAL 3022	RAL 3027	RAL 9003	RAL 9004
RAL 3031	RAL 4001	RAL 4002	RAL 4003	RAL 4004	RAL 4005	RAL 4006	RAL 4007	RAL 7003	RAL 7004
RAL 4008	RAL 4009	RAL 5000	RAL 5001	RAL 5002	RAL 5003	RAL 5004	RAL 5005	RAL 7012	RAL 7013
RAL 5007	RAL 5008	RAL 5009	RAL 5010	RAL 5011	RAL 5012	RAL 5013	RAL 5014	RAL 7026	RAL 7030
RAL 5015	RAL 5017	RAL 5018	RAL 5019	RAL 5020	RAL 5021	RAL 5022	RAL 5023	RAL 7037	RAL 7038
RAL 5024	RAL 6000	RAL 6001	RAL 6002	RAL 6003	RAL 6004	RAL 6005	RAL 6006	RAL 8001	RAL 8002
RAL 6007	RAL 6008	RAL 6009	RAL 6010	RAL 6011	RAL 6012	RAL 6013	RAL 6014	RAL 8014	RAL 8015
RAL 6015	RAL 6016	RAL 6017	RAL 6018	RAL 6019	RAL 6020	RAL 6021	RAL 6022	RAL 8025	RAL 8028
RAL 6024	RAL 6025	RAL 6026	RAL 6027	RAL 6028	RAL 6029	RAL 6032	RAL 6033	RAL 9011	RAL 9016
RAL 6034	RAL 7000	RAL 7001	RAL 7002	RAL 7003	RAL 7004	RAL 7005	RAL 7006	RAL 7031	RAL 7032
RAL 7010	RAL 7011	RAL 7044	RAL 8000	RAL 9005	RAL 9010	RAL 7031	RAL 7032	RAL 7039	RAL 7040
RAL 7023	RAL 7024	RAL 8011	RAL 8012	RAL 7005	RAL 7006	RAL 7039	RAL 7040	RAL 8003	RAL 8004
RAL 7035	RAL 7036	RAL 8023	RAL 8024	RAL 7015	RAL 7016	RAL 8003	RAL 8004	RAL 8016	RAL 8017
RAL 9017	RAL 9018	RAL 9001	RAL 9002						

FIRE CABINETS

ACCESSORIES

Lock Options

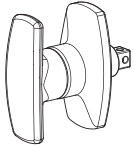

Polyamide
Nickel Chrome Plated Mild Steel
Nickel Chrome Plated SS 316

T-HANDLE LOCK
WITHOUT KEY

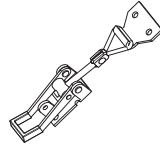

SS 316

TOGGLE LATCH

Hinges



LIFT-OFF TYPE

Zinc Die Cast
SS 316
Chrome Plated SS 316

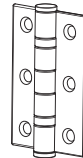

BUTT TYPE 3 INCHES

SS 316
SS 304

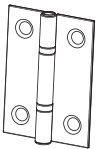

BUTT TYPE 2 INCHES

SS 316
SS 304

Canopies

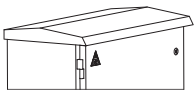

LARGE CANOPY

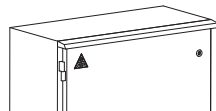

SMALL CANOPY

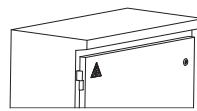

IN-BUILT CANOPY

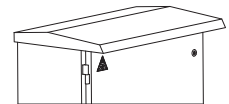

FRONT EXTENDED
LARGE CANOPY

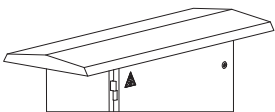

2 SIDES EXTENDED CANOPY

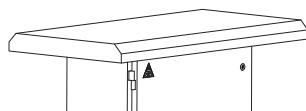

4 SIDES EXTENDED CANOPY

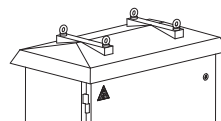

CANOPY WITH LIFTING HOOKS

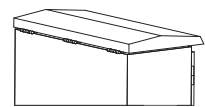

HINGED OPEN TYPE CANOPY

FIRE CABINETS

Glass Windows

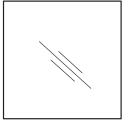

Toughened Glass
Polycarbonate

GLASS WINDOW



Toughened Glass
Polycarbonate

GLASS WINDOW WITH GASKET

Gaskets



V TYPE

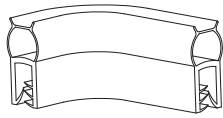

BULB TYPE

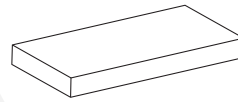

FLAT TYPE



PROFILE TYPE

Ventilators

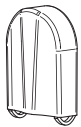

IP 43 VENTILATOR



IP 54 VENTILATOR

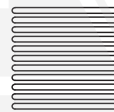

SLOTTED NATURAL VENTILATION

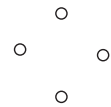

SMALL HOLES NATURAL VENTILATION

Fixing Arrangements

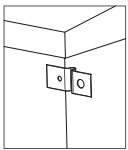

STEP TYPE WALL MOUNTING BRACKET

SS 316

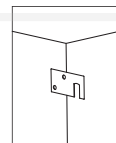

FLAT TYPE WALL MOUNTING BRACKET

SS 316

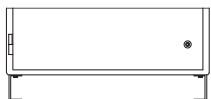

PEDESTAL TYPE 1

Galvanized Iron
GRP

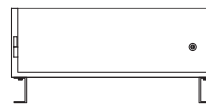

PEDESTAL TYPE 2

Galvanized Iron
GRP

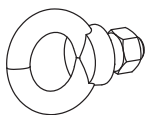

LIFTING HOOK

SS 316
Galvanized Iron

FIRE CABINETS

Miscellaneous Add-ons

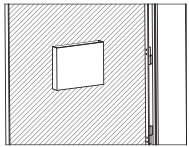

DRAWING POCKET

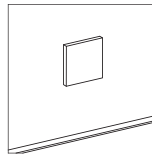

INTERNAL PADDING

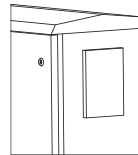

EXTERNAL PADDING

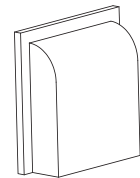

GRP HOOD

